

HULALA

H O M E

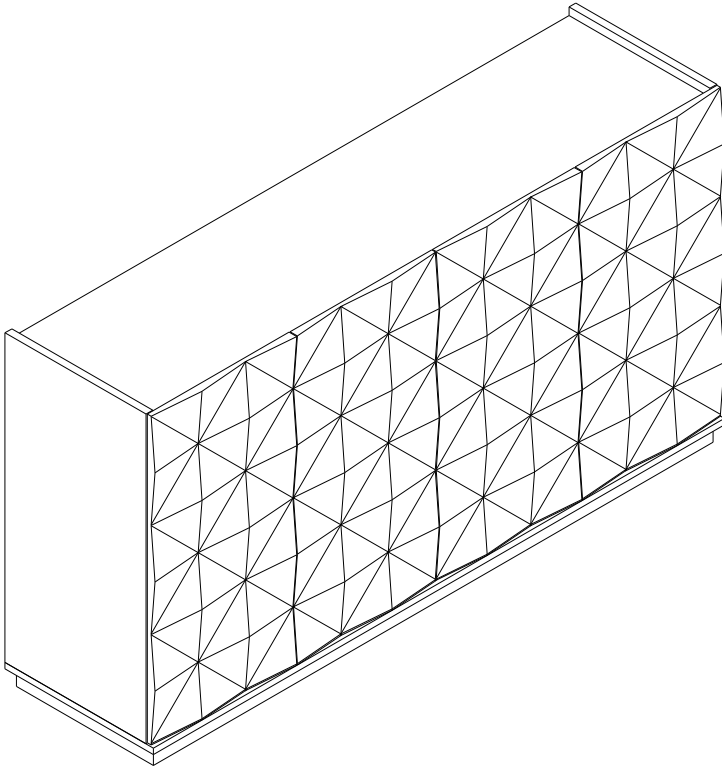

ITEM NO.SBHM0777

NOTE:

This brochure contains IMPORTANT safty info. Please read and keep for future reference.

MAINTAINANCE AND WARNING

- 1.Keep furniture away from heat sources.
- 2.Do not clean furniture with harsh cleaner or polishes.Do not use detergents,solvents,abrasives,spray packs or leather cleaner. Use non-color mild soa with warm water to clean spills(Mix 1:10 soap to water).
- 3.Do not place furniture under direct sunlight,material will possibly fade over time.
- 4.Do not use on site dry cleaning machine.Children should not climb or jump on the furniture.
- 5.Do not write on furniture that is not protectedby a padded barrier.
- 6.Not for commercial use,only for residential use.



Weight Limitation
100 LBS

EXPLOSIVE VIEW

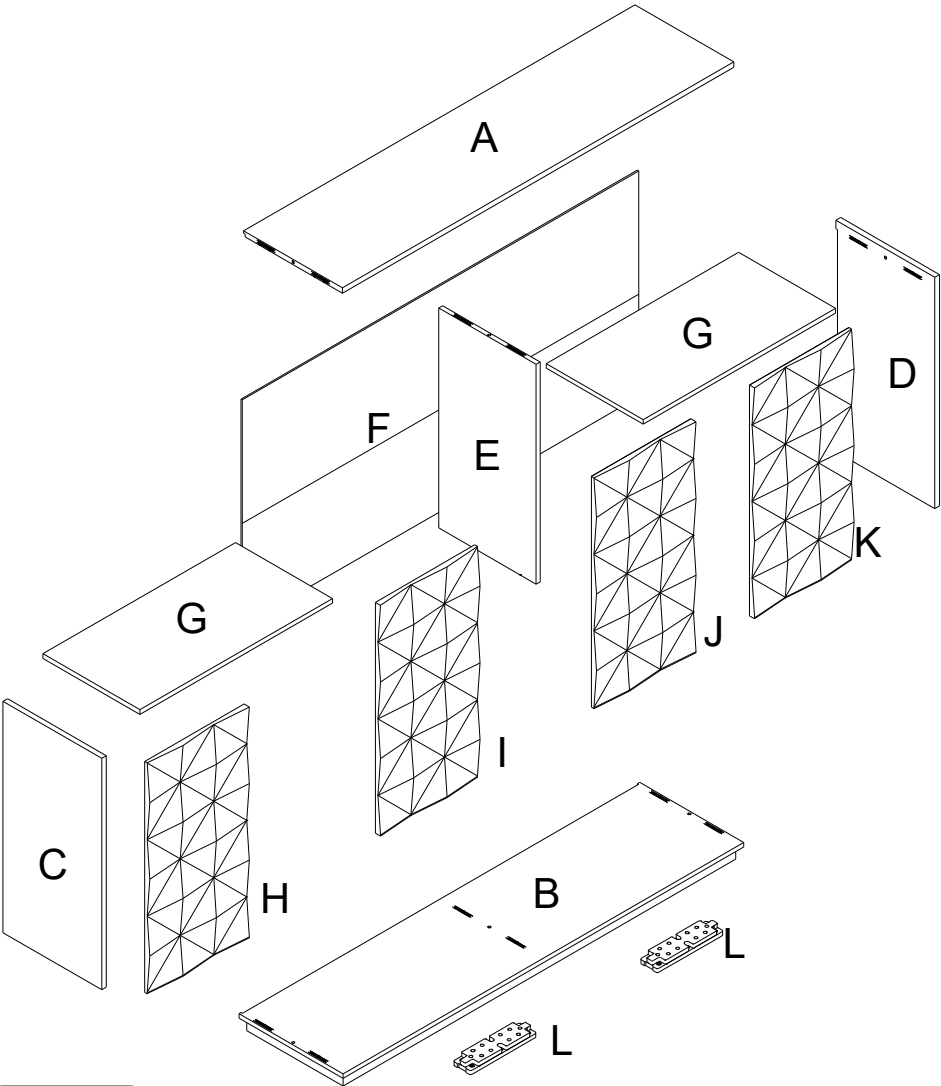

2 PERSONEN







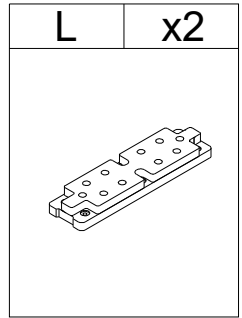
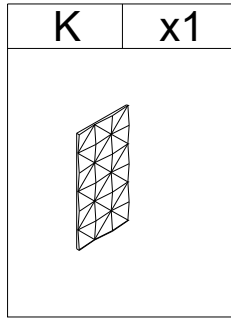
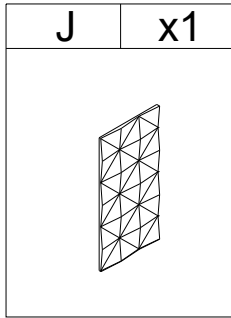
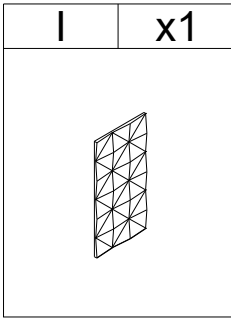
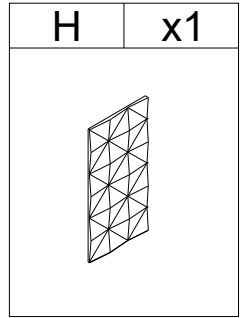
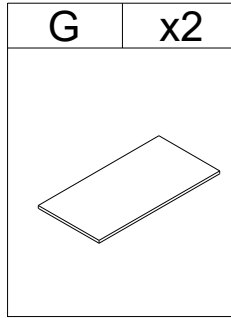
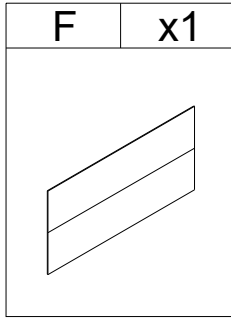
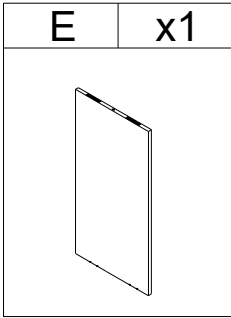
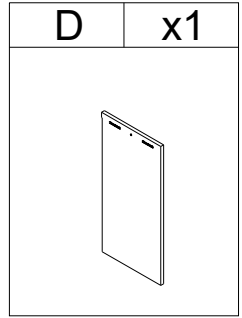
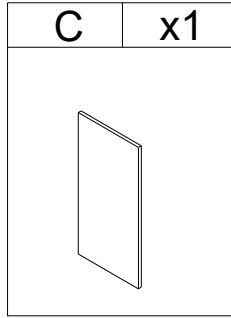
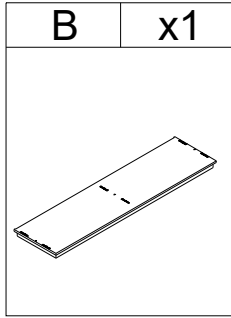
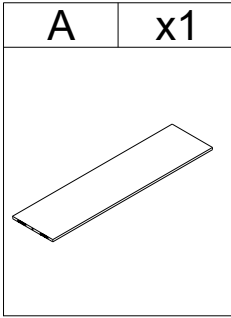

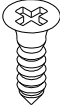

An icon showing two stylized human figures, indicating that two people are required for the installation of this product.

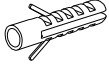
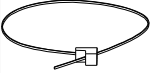

PARTS LIST



HARDWARE LIST

#1	x30	#2	x52	#3	x8	#4	x4	#5	x4	#6	x4
											
Ø3*14mm*6		Ø3.5*14mm*7									
#7	x2	#8	x4	#9	x16	#12	x1				
											
				Ø3.5*35mm*7							

TOOL LIST

#10	x1	#11	x1
			
M4		M5	

HARDWARE SPARE LIST

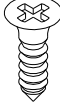
#1	x1	#2	x1
			
Ø3*14mm*6		Ø3.5*14mm*7	

ASSEMBLY INSTRUCTIONS

STEP-1

1. Use screw #9 to attach the weight parts L to bottom panel B, tighten screws with screwdriver #11.

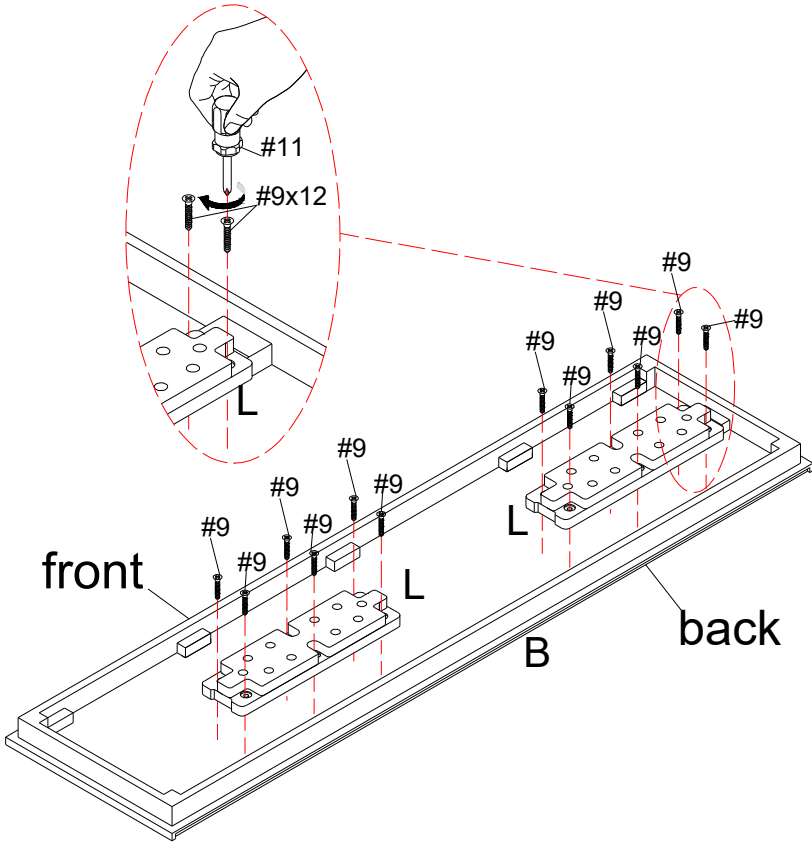

#9	x12
	
Ø3.5*35mm*7	

#11	x1
	
M5	

ASSEMBLY INSTRUCTIONS

STEP-2

1. Insert side panel (C&D) into top panel (A), make sure all holes aligned and then tighten it with allen key #10 as picture show.

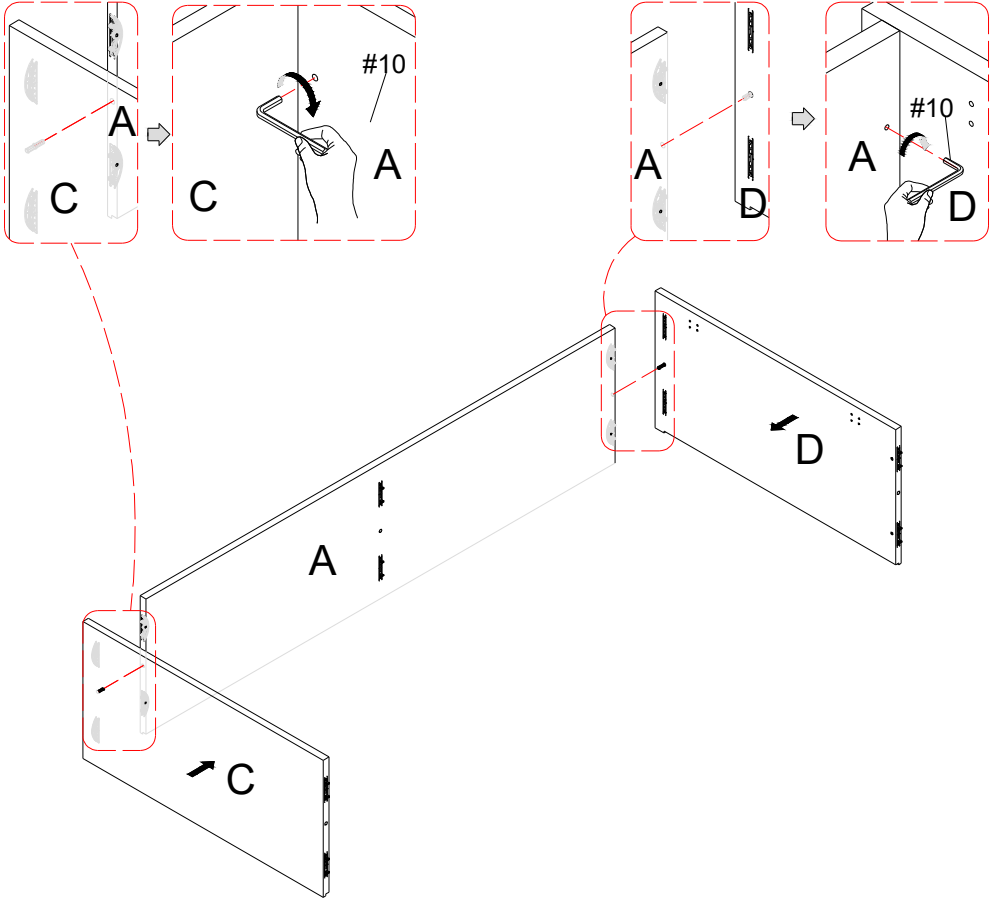



#10	x1
	
M4	

ASSEMBLY INSTRUCTIONS

STEP-3

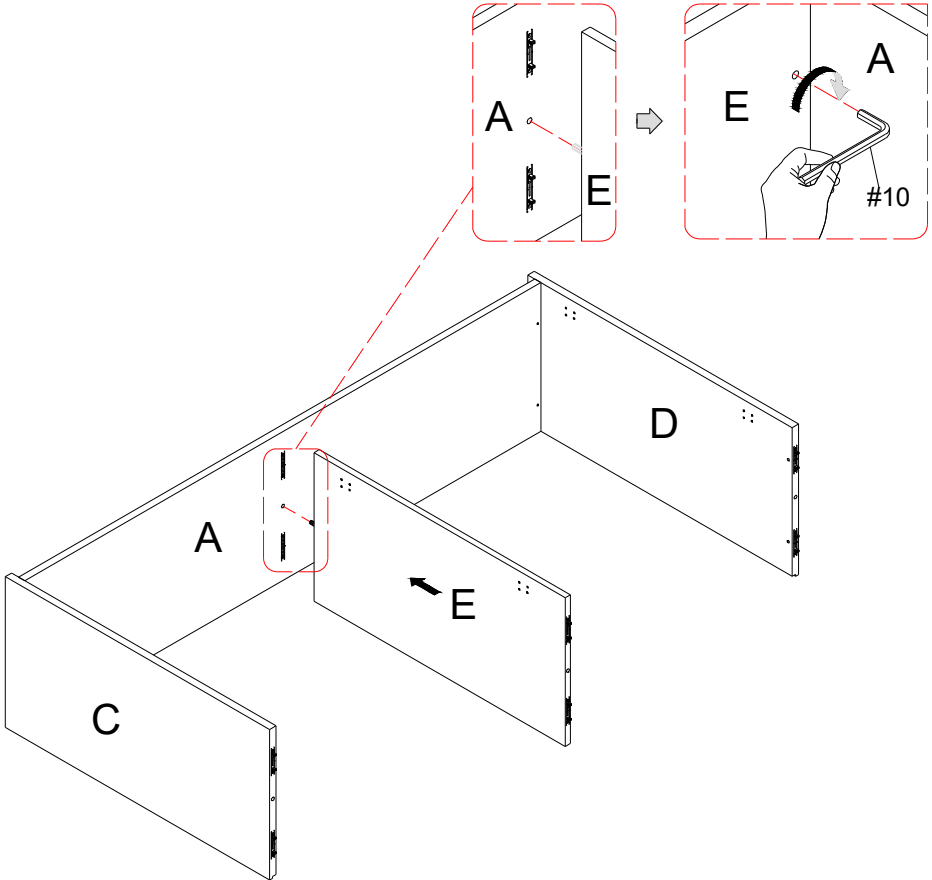
1. Insert middle panel (E) into top panel (A), make sure all holes aligned and then tighten it with allen key #10 as picture show.





#10	x1
	
M4	

ASSEMBLY INSTRUCTIONS

STEP-4

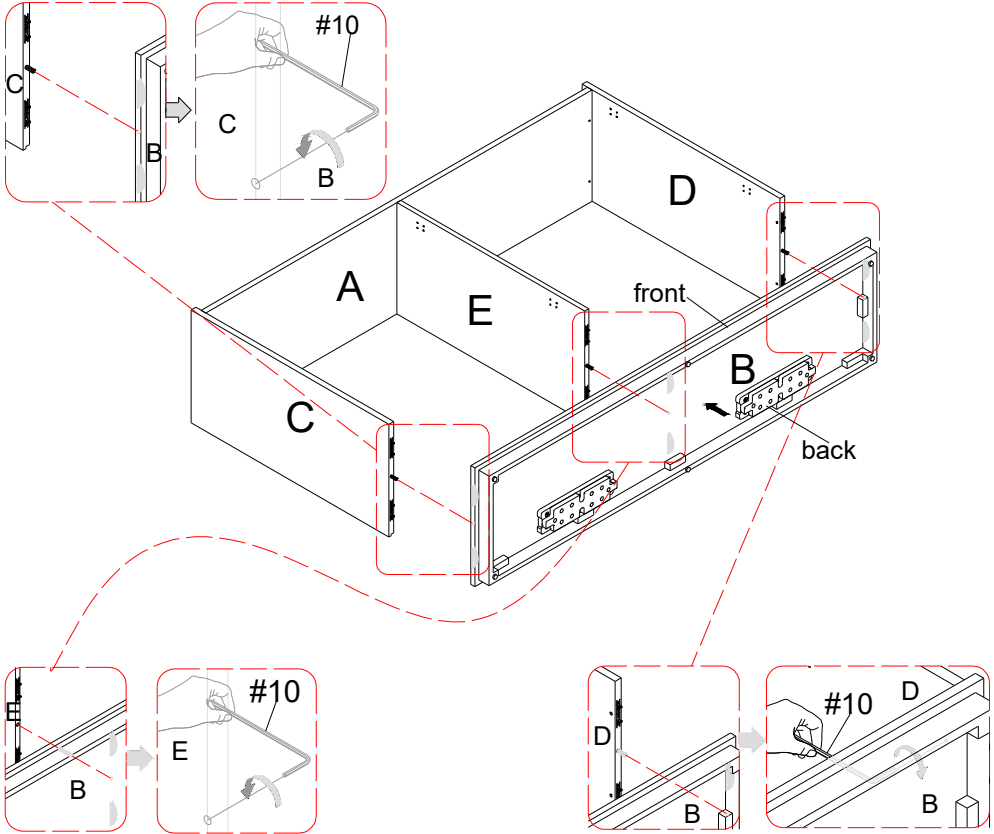
1. Insert bottom panel (B) into pre-assembled unit at step 3, make sure all holes aligned and then tighten it with allen key #10 as picture show.





#10	x1
	
M4	

ASSEMBLY INSTRUCTIONS

STEP-5

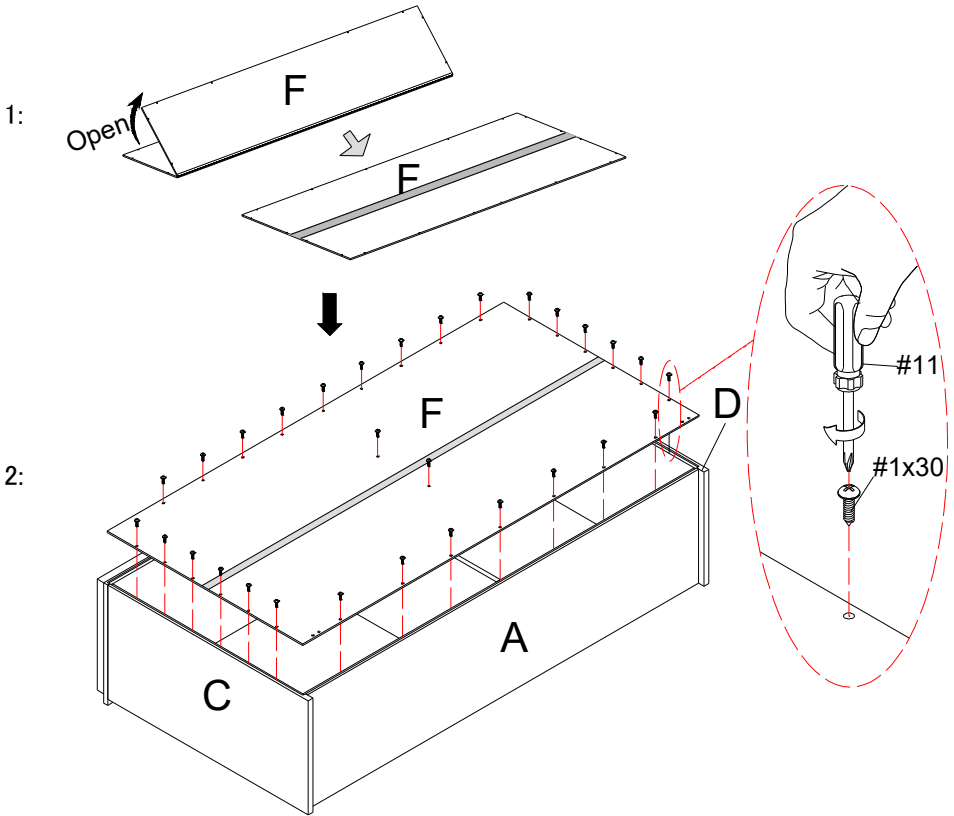
1. Open the panel (F), insert panel (F) into the groove of pre-assembled step 4, and then use screw #1 to attach panel (F) to the pre-assembled step 4, tighten it with screwdriver #11.



#1	x30
	
Ø3*14mm*6	

#11	x1
	
M5	

ASSEMBLY INSTRUCTIONS

STEP-6

1. Insert shelf pin #3 into pre-assembled unit at step 5.

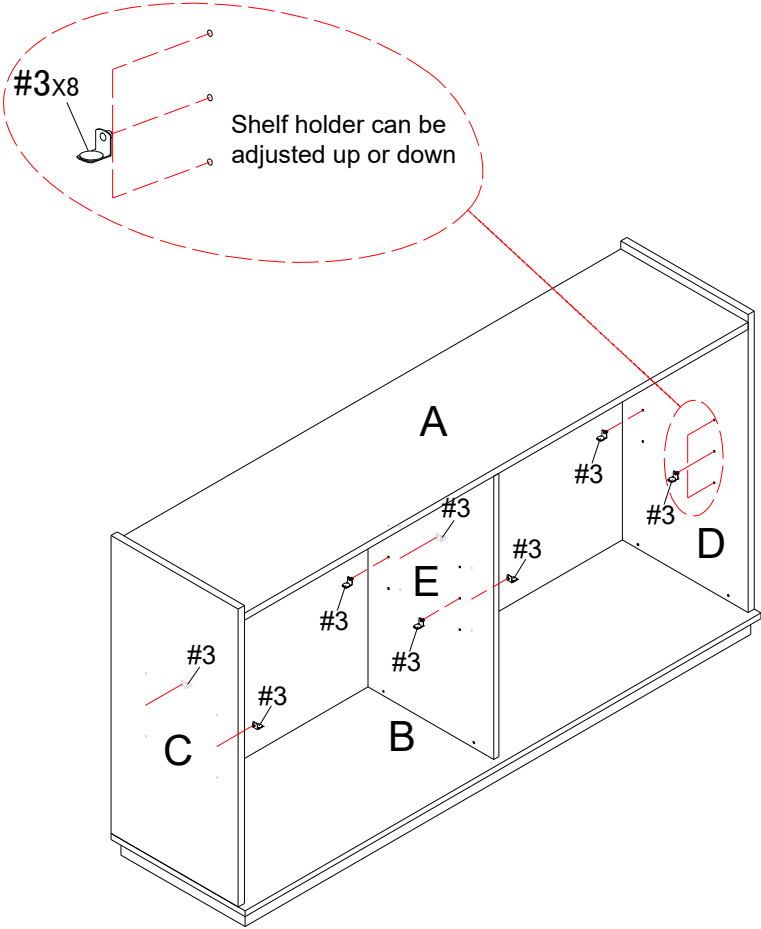

#3	x8
	

ASSEMBLY INSTRUCTIONS

STEP-7

1. attach adjustable shelf (G) to pin #3.

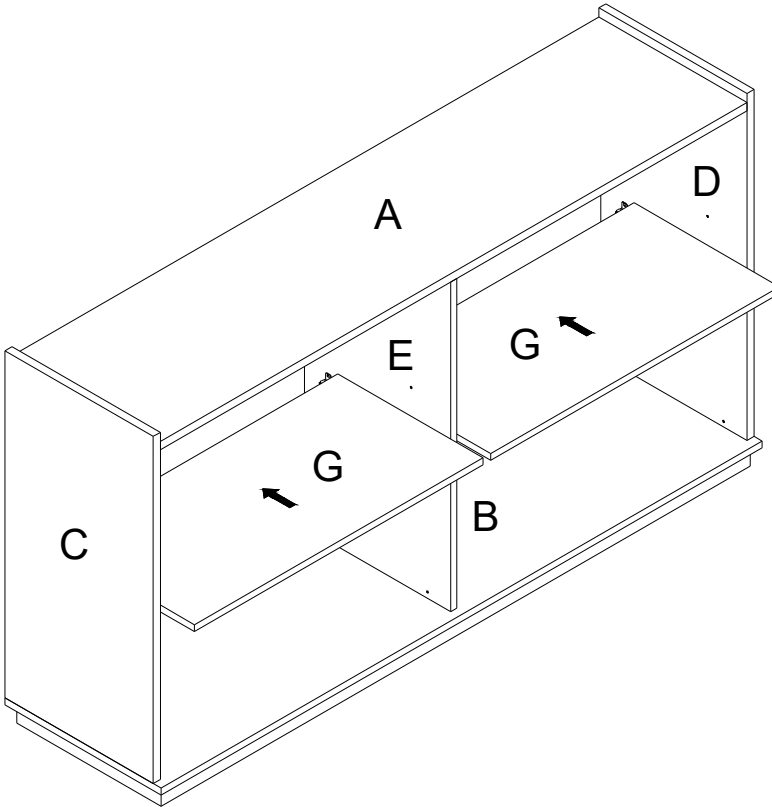



ASSEMBLY INSTRUCTIONS

STEP-8

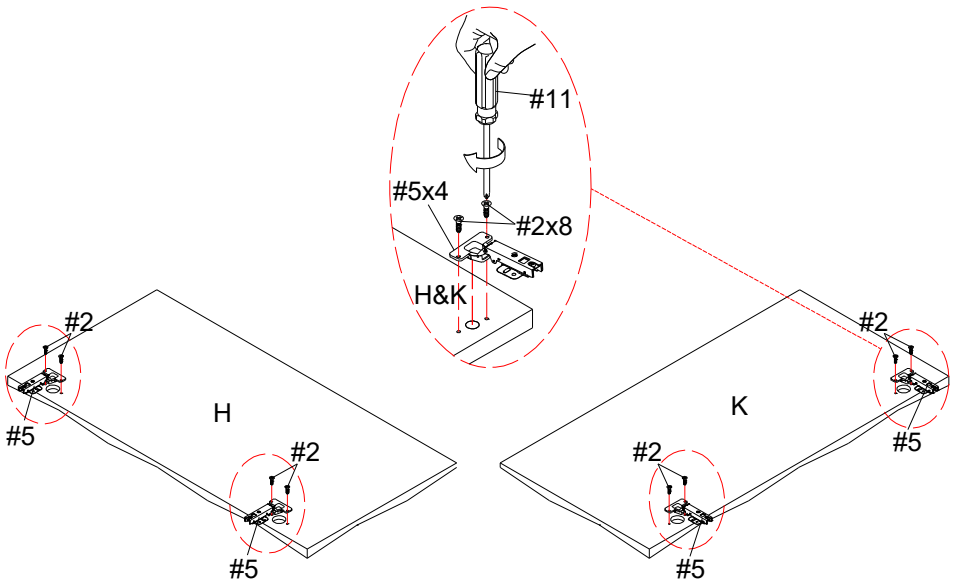
1. Use screw #2 to attach the hinges #5 to door panel (H)&(K), tighten screws with screwdriver #11.

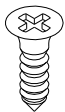





#2	x8	#5	x4	#11	x1
					
Ø3.5*14mm*7				M5	

ASSEMBLY INSTRUCTIONS

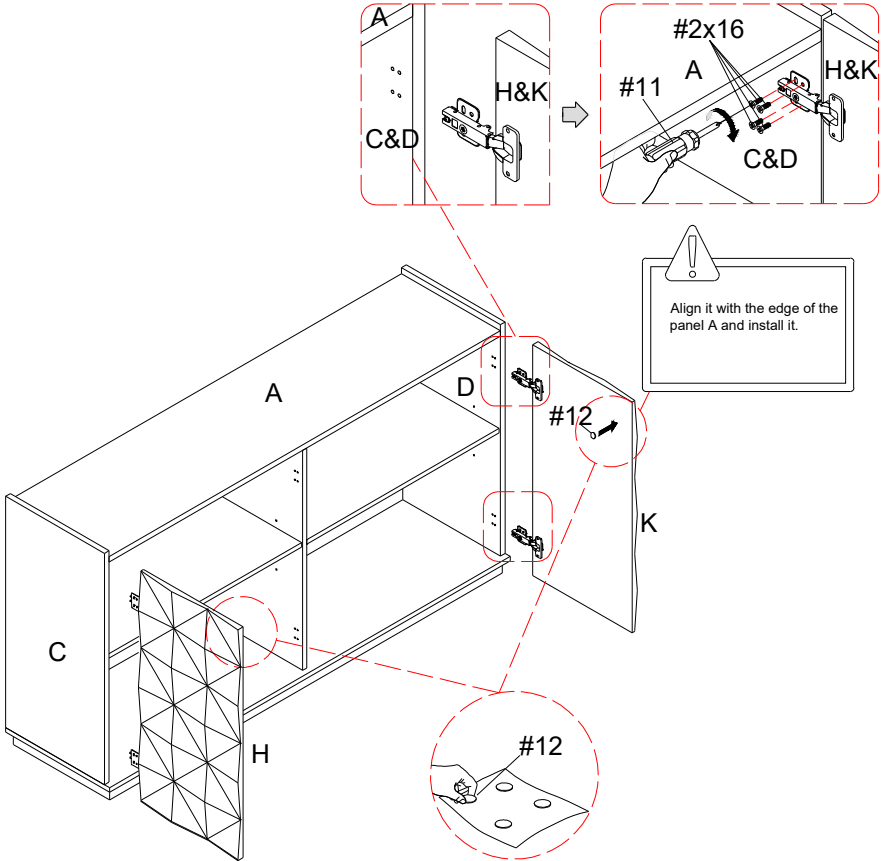
STEP-9

1. Use screw #2 to attach left door (H) and right door (K) to pre-assemble unit at step 7, tighten screw with screwdriver #11. Stick parts #12 on door panel H&K as image.





#2	x16	#11	x1	#12	x1
					
Ø3.5*14mm*7		M5			

ASSEMBLY INSTRUCTIONS

STEP-10

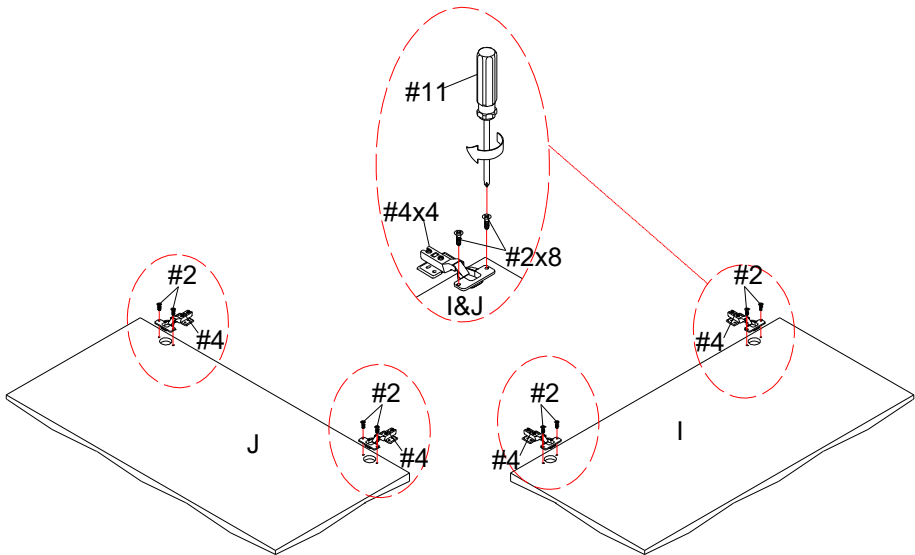
1. Use screw #2 to attach the hinges #4 to door panel (I)&(J), tighten screws with screwdriver #11.

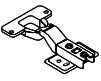

#4	x4	#2	x8	#11	x1
					
		Ø3.5*14mm*7		M5	



ASSEMBLY INSTRUCTIONS

STEP-11

1. Use screw #2 to attach middle door (I) to pre-assemble unit at step 9, tighten screw with screwdriver #11.

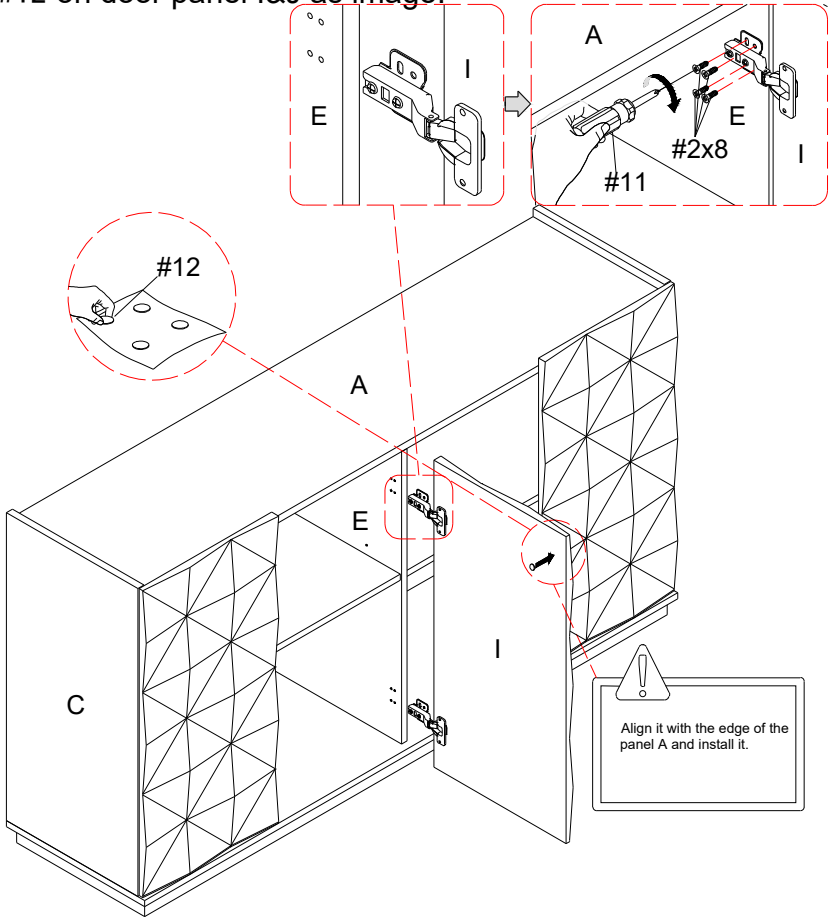
Stick parts #12 on door panel I&J as image.

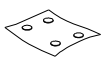

#2	x8	#11	x1	#12	x1
					
Ø3.5*14mm*7		M5			



ASSEMBLY INSTRUCTIONS

STEP-12

1. Use screw #2 to attach middle door (J) to pre-assemble unit at step 11, tighten screw with screwdriver #11.

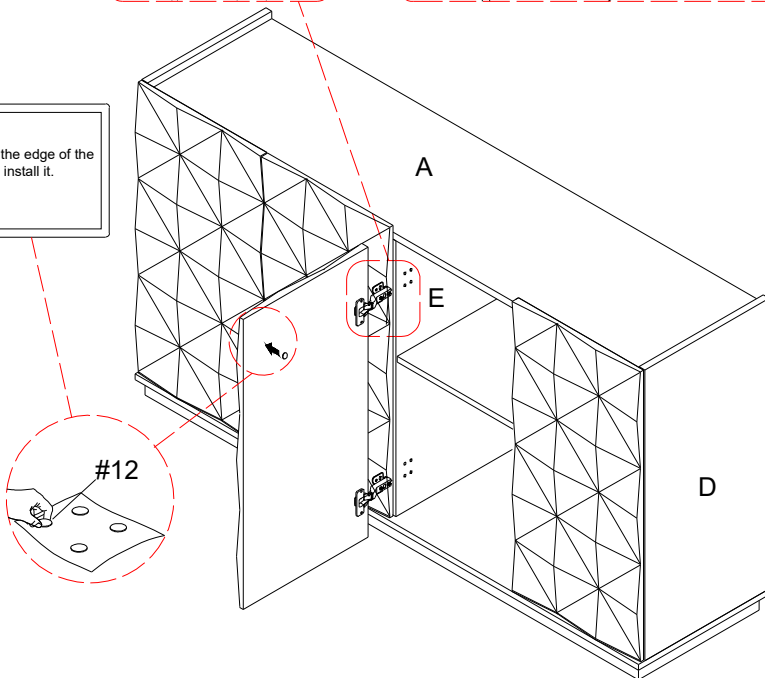
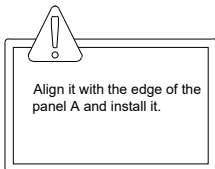
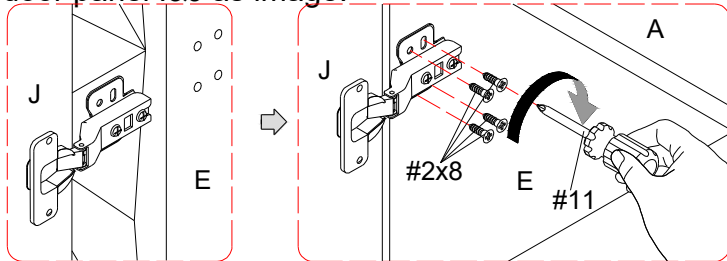
Stick parts #12 on door panel I&J as image.

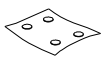

#2	x8	#11	x1	#12	x1
					
Ø3.5*14mm*7		M5			

ASSEMBLY INSTRUCTIONS

STEP-13

Concealed hinges are three-way adjustable:

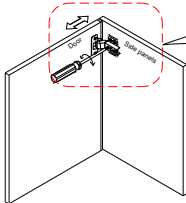

Horizontal
by screw adjustment!

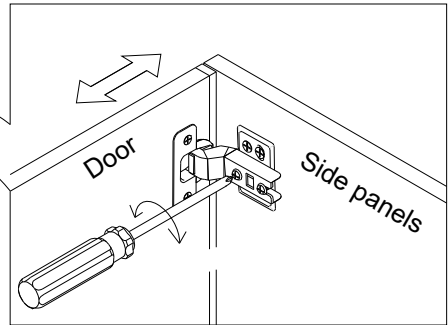

Concealed hinges are three-way adjustable:

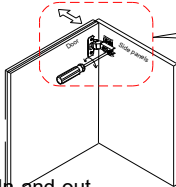

In-and-out
by loosening the hinge arm
mounting screw or via cam
adjustment!

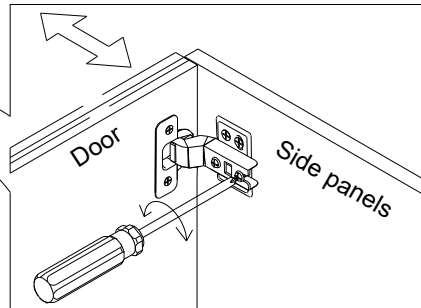

Concealed hinges are three-way adjustable:

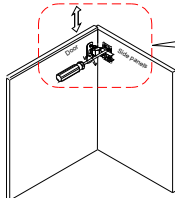

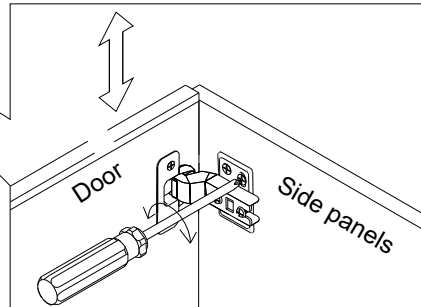

Vertical via slots in
the mounting plate
or via cam adjustment!



Video for door adjustment

Hinge adjustment method

ASSEMBLY INSTRUCTIONS



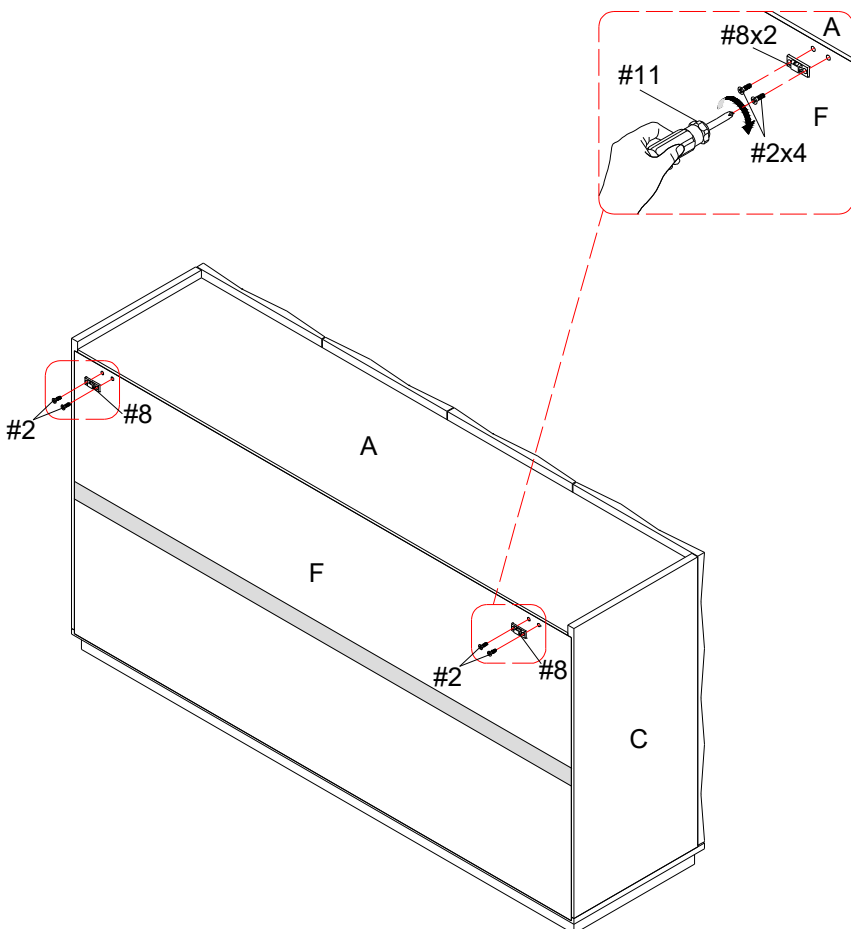

#2	x4	#8	x2	#11	x1
					
Ø3.5*14mm*7				M5	

STEP-14

1. Attach part #8 to the corresponding hole in the pre-assembled unit using screw #2 in step 12.



ASSEMBLY INSTRUCTIONS

#6	x4	#8	x2	#9	x4	#11	x1
							
				Ø3.5*35mm*7		M5	

STEP-15

1. Install the anti-collapse device.
2. Mark the position on the wall, that corresponds to the location of part #8 on the back of panel (F); Drill and insert the expandable screw #6 by hammer.
3. Assemble the part #8 to the wall. Align the hole in the part #8 with the expandable screw #6, use screw #9 to attach it and tighten by screwdriver #11.

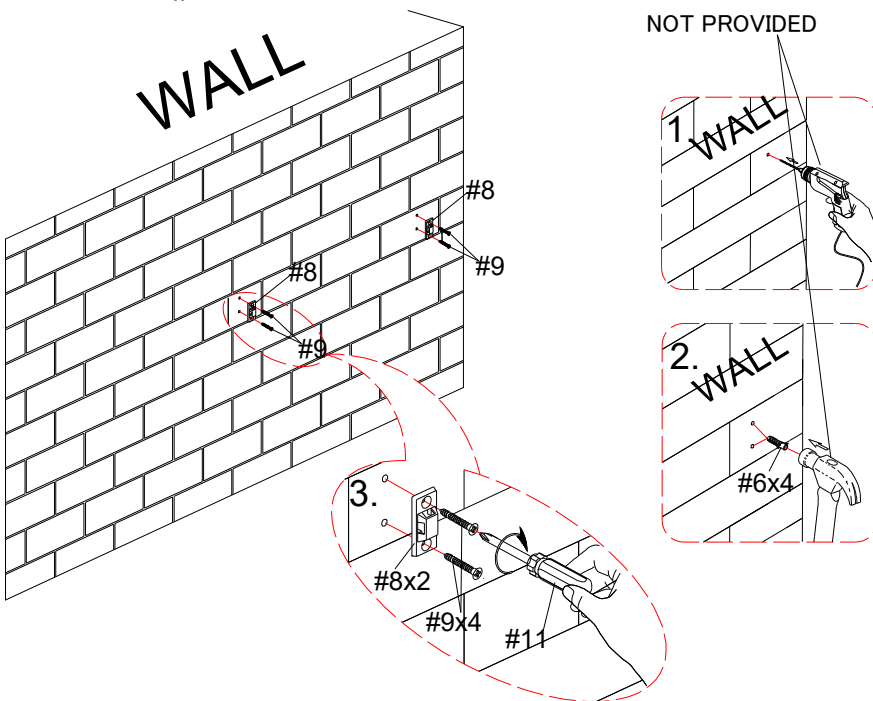

ASSEMBLY INSTRUCTIONS

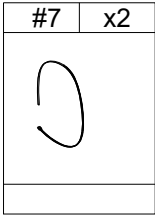

STEP-16

Let the plastic belt #7 pass through the both part #8 and pull tightly.

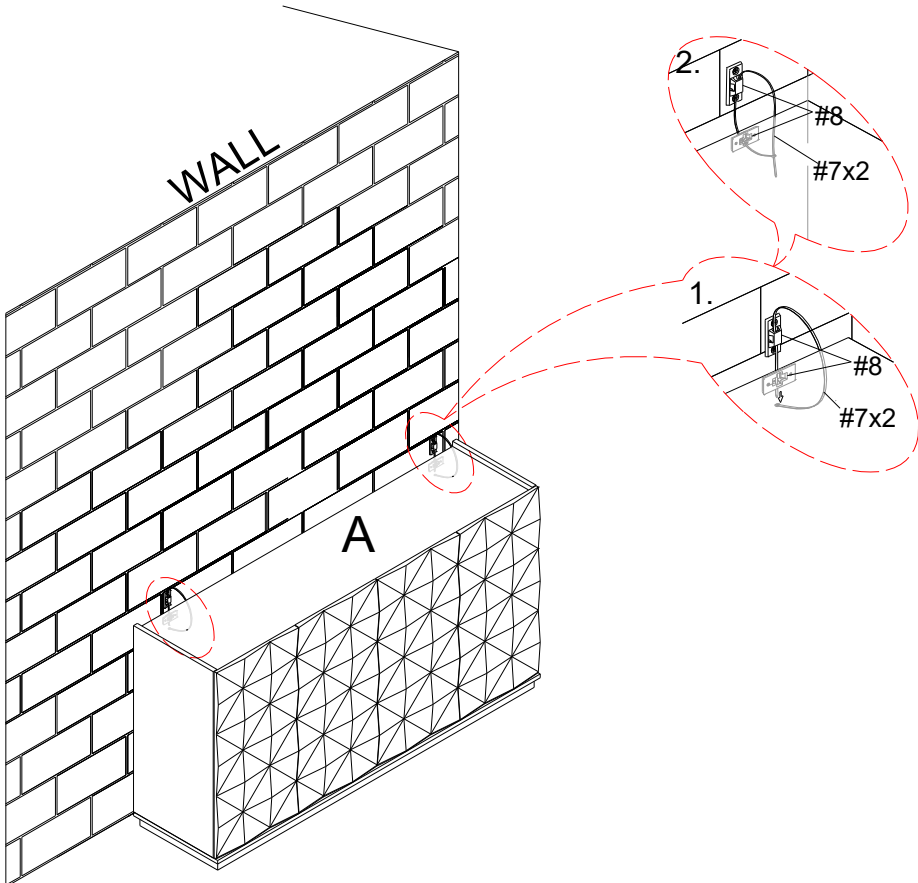

WARRANTY

1. We strive to offer high-quality products, and we also try our best to satisfy each and every customer that orders from us with product or service as needed.
2. We provide 30 days warranty starting from the time you receive the item. Each customer must provide a record of their order such as the order number, or item receipt for any items that are out of the warranty period you may also still receive.
3. Replacement parts by purchasing them with our company if they are available.

Are you having difficulty
With assembly? Missing parts?
Please send email with your order No to
customerservice@hulalahome.com
For return, please check the return policy with
the retailer or market place you bought from.

Appreciate your purchasing from us.
Pop up your life by our furniture piece!