

WARRANTY

We strive to offer high-quality products, and we also try our best to satisfy each and every customer that orders from us with product or service as needed. We provide 30 days warranty starting from the time you receive the item. Each customer must provide a record of their order such as the order number, or item receipt for any items that are out of the warranty period you may also still receive replacement parts by purchasing them with our company if they are available.

**Are you having difficulty
with assembly? Missing parts?**

**Please send email with your order No
customerservice@hulalahome.com**

**For return, Please check the return policy with
the retailer or MarketPlace you bought from.**

Appreciated your purchasing from us.

Pop up your life by our furniture piece!

HULALA
H O M E

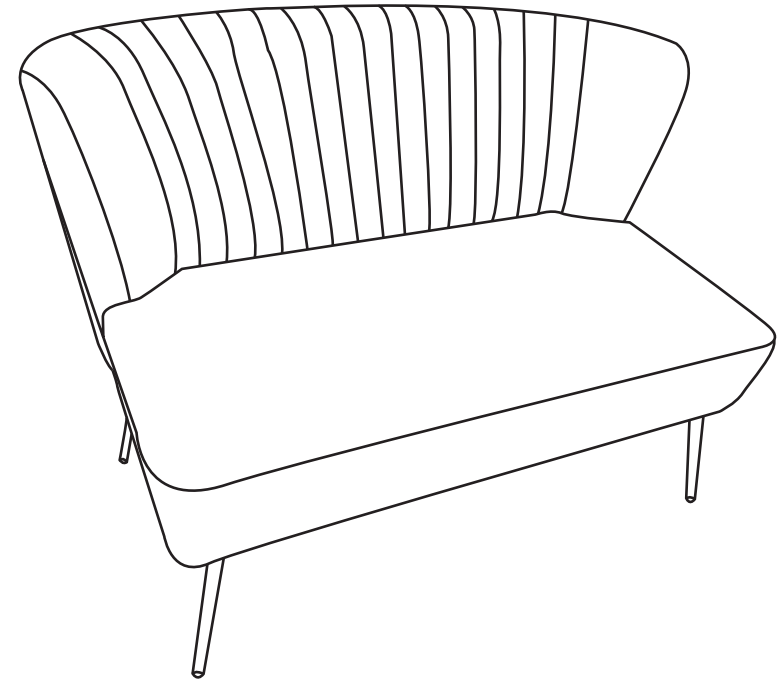

ITEM NO.SFM0436

NOTE:

This brochure contains IMPORTANT safty info. Please read and keep for future reference.

MAINTAINANCE AND WARNING

- Keep furniture away from heat.
- Do not clean furniture with harsh cleansers or polish. Do not use detergents, Solvents, abrasives, spray packs or leather cleaner. Use non-color mild soap with warm water clean spills(Mix 1:10 soap to water)
- Do not place furniture under direct sunlight, material will possibly fade over time.
- Do not use on site dry Cleaning machine.
- Children should not climb or jump on the furniture.
- Do not write on furniture without a padded barrier to protect the surface.
- Not for commercial use, For residential use only.



Weight Limitation

500LBS

PARTS LIST

Ax1

Backrest

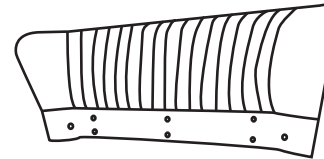

Bx1

Seat



Cx4

Legs

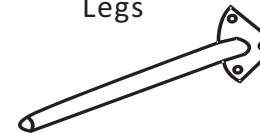

HARDWARE LIST

Dx8
M8x55mm
Screw

Ex12
M6x20mm
Screw

Fx8
Gaskets

Gx8
Gasket clasp

Hx1
M8
Allen Key

Ix1
M6
Allen Key

SPARE

Dx1
M8x55mm
Screw

Ex1
M6x20mm
Screw

Fx1
Gaskets

Gx1
Gasket clasp

Jx1
Adjustable leveler

Be sure to check all packing material carefully for small parts, which may have come loose inside the carton during shipment.

ASSEMBLY INSTRUCTIONS

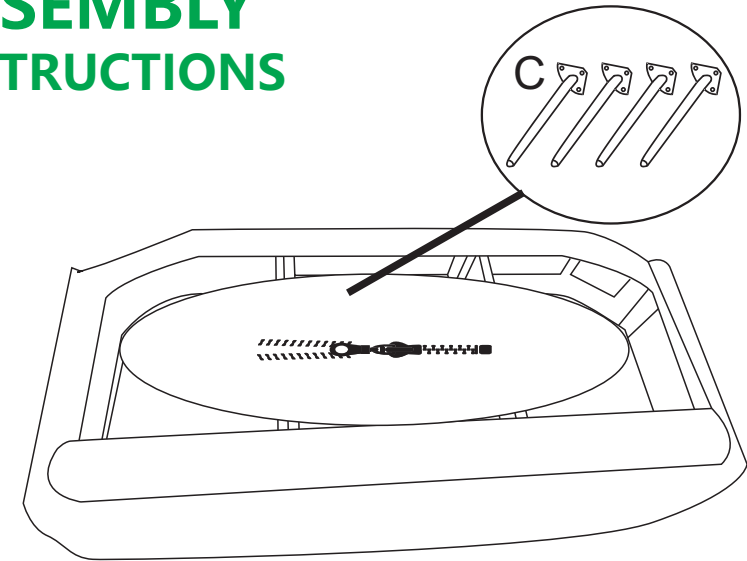

Place the chair seat/back assembly on clean padded surface.

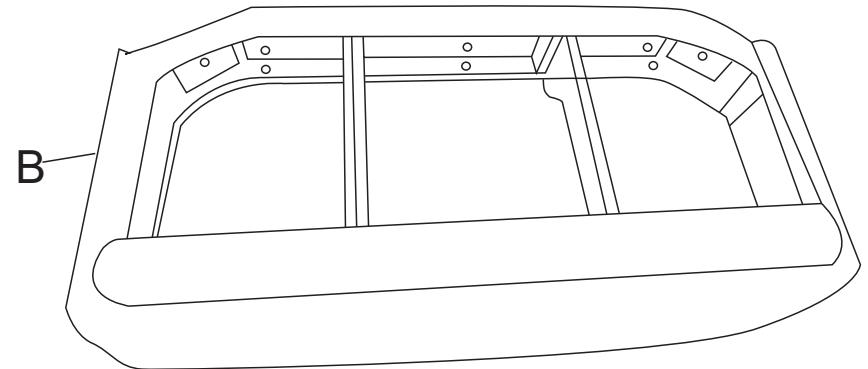

STEP 1 Open the zip on bottom of the seat cushion B under pocket and take out the components. Place the seat cushion B on a clean padded surface.

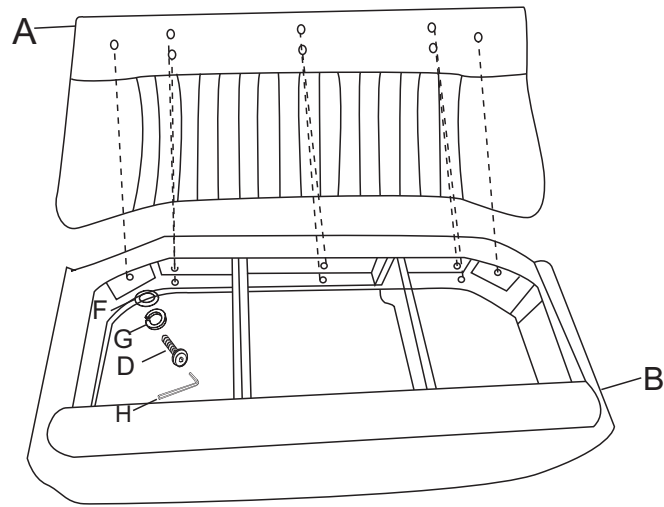

STEP 2 Align hole position on seat cushion B and back A, use bolt D, flat washer F, spring washer G allen wrench H to connect seat and back, Don't fasten any bolt until all bolts connected properly and position aligned correctly.

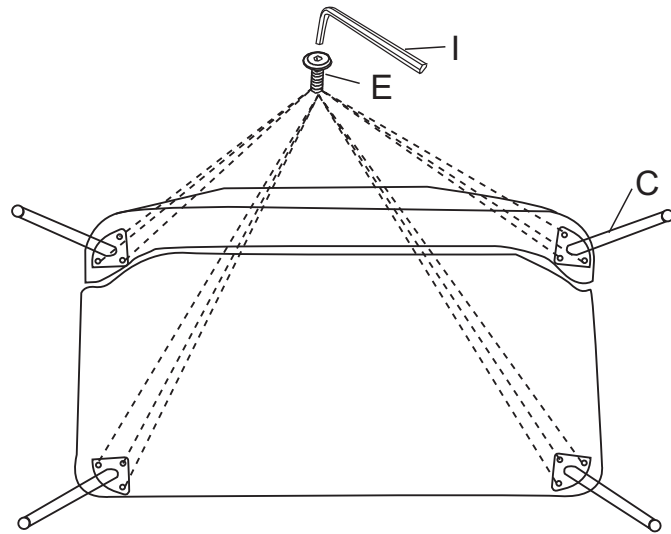

STEP 3 Use bolt E, allen key I to attach legs bottom of the seat cushion and fasten all bolts.

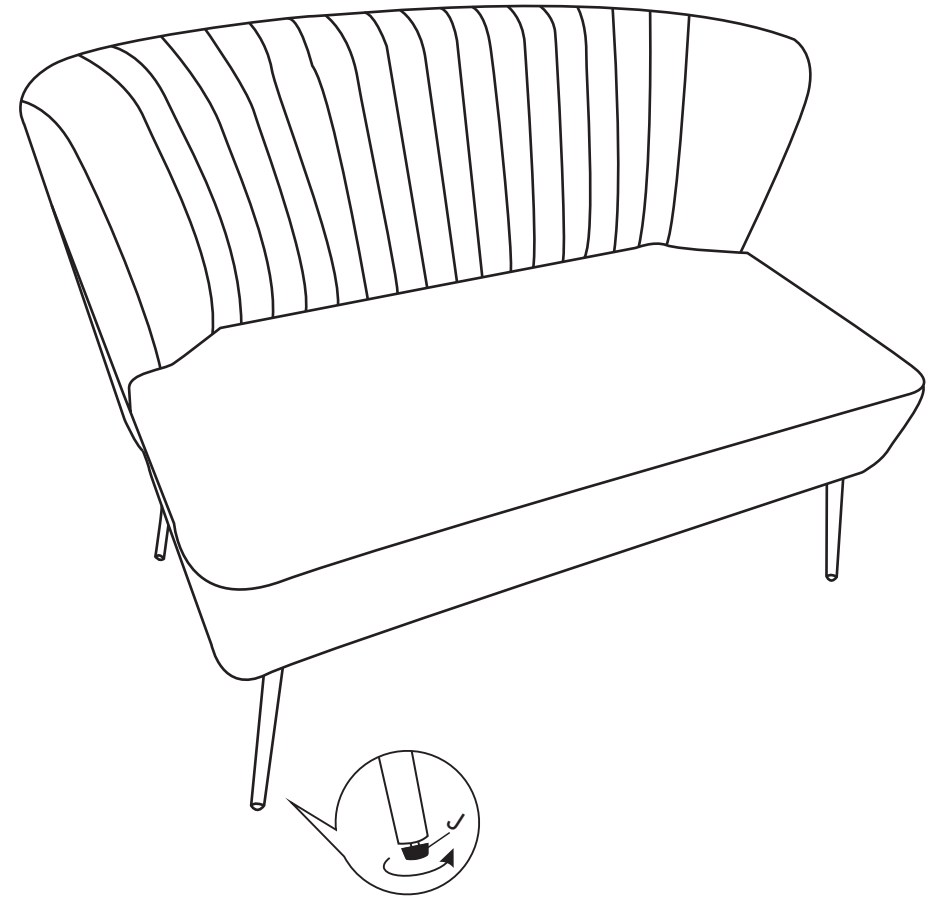

Adjust levelers under legs to set the loveseat level.

STEP 4 Assembly completed.